



5000
Digital Indicator
Quick Start Manual

For use with Software Versions 5.0 and above

5000-601-501

Copyright

All Rights Reserved. No part of this document may be copied, reproduced, republished, uploaded, posted, transmitted, distributed, stored in or introduced into a retrieval system in any form, or by any means (electronic, mechanical, photocopying, recording or otherwise) whatsoever without prior written permission of Rinstrum Pty Ltd.

Disclaimer

Rinstrum Pty Ltd reserves the right to make changes to the products contained in this manual in order to improve design, performance or reliability.

The information in this manual is believed to be accurate in all respects at the time of publication, but is subject to change without notice. Rinstrum Pty Ltd assumes no responsibility for any errors or omissions and disclaims responsibility for any consequences resulting from the use of the information provided herein.

SPECIAL NOTE

Trade Use of the Rinstrum 5000

This manual may occasionally make reference to Trade Use settings of the **5000**. Only properly marked Trade Certified versions of the **5000** can be used in **Legal for Trade** applications.

Some individual settings may not be legal for trade use. Please check regulations with the appropriate Weights and Measures Authority.

“Everything should be made as simple as possible, but not simpler.”

- Albert Einstein -



Table of Contents

1.	INTRODUCTION	4
1.1.	Introduction	4
1.2.	Features	4
1.3.	Accessories.....	4
1.4.	Manuals.....	4
2.	SPECIFICATIONS.....	5
3.	INSTALLATION	6
4.	CONNECTIONS	7
4.1.	Connecting Shields	7
4.2.	Unused Pins.....	8
4.3.	5000 Rear Plate Connections	8
4.4.	DC Power Supply.....	8
4.5.	6-Wire Load Cell Connection	8
4.6.	4-Wire Load Cell Connection	9
4.7.	Serial Connection.....	9
4.8.	Accessory Card Installation.....	10
4.9.	Accessory Card Connection.....	10
5.	SETUP.....	11
5.1.	Accessing Full or Safe Setup	11
5.2.	Exiting Full or Safe Setup.....	11
6.	ERROR MESSAGES	16
6.1.	Weighing Errors	16
6.2.	Setup Errors	16
6.3.	Calibration Errors	16
6.4.	Diagnostic Errors.....	17

1. Introduction

1.1. Introduction

The **Rinstrum 5000** is a precision industrial digital indicator using the latest technology to ensure fast and accurate weight readings.



1.2. Features

The indicator is fitted with an alphanumeric 14.5mm LED display

- Real Time Clock and RAM for storing Zero, Tare and Total settings, etc.
- Support for Setpoint or Combo Accessory Cards.

1.3. Accessories

- 0107 12VDC 1A Plug Pack Power Supply for use with DC models.
- 0212 Combo Accessory Card. 2 open collector outputs, 1 input and voltage or current analog outputs.
- 0204 Setpoint Accessory Card: 4 open collector outputs and 4 inputs.
- 0081 RS-232-20mA Loop Converter.
- 0215 DIN rail Relay Module.
- 0220 Viewer Software
- 0301 Panel Mount Clamps / 0302 Swivel Mount Clamps.
- 0303 30-degree Fixed Desk Mount Bracket.
- 0304 Stainless Steel IP65 Housing
- 0305 Stainless Steel Desk Bracket (requires 0302)
- 0306 Stainless Steel Wall Bracket (requires 0302)

1.4. Manuals

For more information on the **5000** refer to the **5000 Reference Manual** and **5000 Communications Manual** (available free of charge from www.rinstrum.com).

2. Specifications

Performance	
Display	6 digit green LEDs, 14.5mm high
Display Resolution	Up to 100,000 divisions, minimum of 0.15 $\mu\text{V}/\text{division}$
Count-By	1, 2, 5, 10, 20, 50, 100 (Entered in Displayed Weight)
Operating Modes	Single Range, Dual Interval and Dual Range
Zero Cancellation	+ / - 2.0mV/V
Span Adjustment	0.1mV/V to 3.0mV/V full scale
Stability/Drift	Zero: < 0.1 $\mu\text{V}/^\circ\text{C}$, Span < 10ppm/ $^\circ\text{C}$, Linearity < 20ppm, Noise < 0.05 μV p-p
Operating Environment	Temperature -10 to +50 $^\circ\text{C}$, Humidity < 90% non condensing
Digital	
Setup And Calibration	Full digital with visual prompting in plain messages
Memory Retention	Full non-volatile operation
Digital Filter	Averaging from 1 to 200 consecutive readings
Zero Range	Adjustable from 4% to 100% of full capacity
A/D Converter	
Type	24 bit Sigma Delta
Resolution	8,388,608 internal counts.
A/D Sync Filter	Adjustable, 15 to 60 cycles /second, FIR filter > 80dB
Load Cells	
Excitation	8 volts for up to 8 x 350 ohm load cells
Load Cell Connection	6-wire + shield
Serial Comms (Factory License option)	
Serial Outputs	Dual RS-232, plus RS-485
Capabilities	Automatic transmit, network, or printer drive
Clock	Battery backed clock and calendar fitted
Dimensions	
Case Size	150mm wide x 72mm high x 100mm deep
Panel Cutout	DIN 43 700 - 137(+1)mm wide x 68(+1)mm high
Power Supply Options	DC 12-15 volts DC 0.7A (Not for Trade Use) DC 12/24VDC 10VA AC 86 - 260VAC 48 - 62Hz 8VA
Options	
Analog Option Card	0-10 volts and 4-20mA opto isolated (10,000 count)
Setpoint Option Card	4 x isolated 50volt, 500mA open collector transistor drives and 4 x isolated digital inputs (5V to 28V).
Combo Option Card	-10 to10 V or 4-20mA opto isolated analog output, two outputs and one input as per the Setpoint option card.
No. of Option Slots	One
Features	
	Approved to OIML 6000 divisions, CE and C-Tick approved.
	Five point linearity correction
	Adjustable anti-vibration filter

3. Installation

The following steps are required to install the **5000** indicator.

- First inspect the unit to ensure that it is in good condition, and that the required mounting options and connectors are available.
- Use the connection diagrams to wire up the load cell, power and serial cables as required. Connectors for all of these cables are supplied with the indicator.
- Connect Power to the unit to start the instrument.
- Follow the instructions in INSTRUMENT SETUP to configure and calibrate the instrument.
- Enter SAFE and FULL setup to protect the settings from tampering and record these in a safe place for future reference.

4. Connections

4.1. Connecting Shields

To obtain full EMC or for RFI immunity with the **5000**, the load cell shield **MUST** be connected electrically to the metal shell of the DB9 connector. Refer to diagrams below or to instructions supplied with the connector.

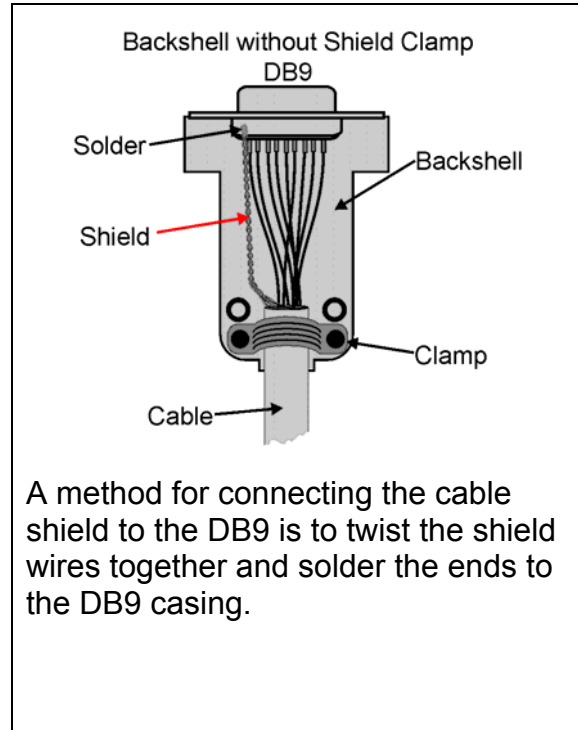
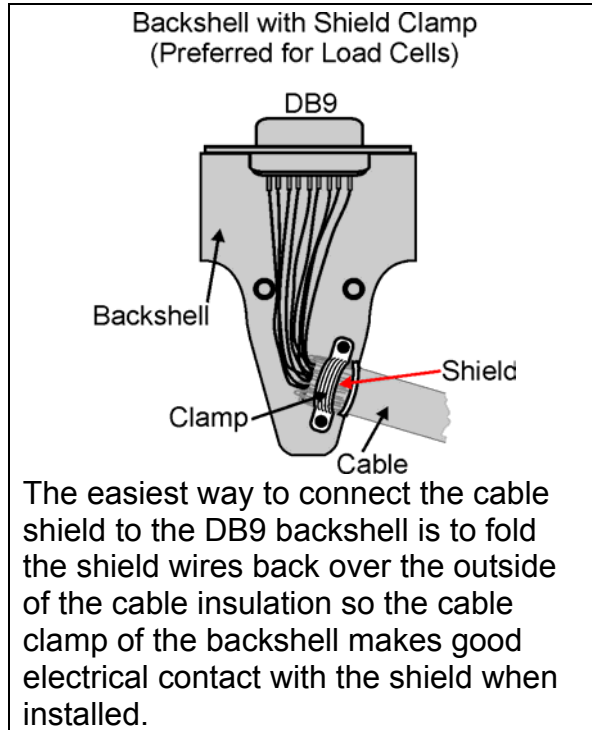

4.1.1. Cable Shield Connection and Earthing

- Care should be taken when connecting shields to maximise RFI immunity and minimise earth loops and cross-talk (interference) between instruments.
- For RFI immunity, termination of the load cell shield at the **5000** end is important (ie. with connection to the **5000** case via the shield connection).
- The **5000** enclosure is directly connected to the shield connections on the cables.
- The **5000** should be connected to earth via a single reliable link to avoid earth loops.
- Where each instrument is separately earthed, interconnecting cable shields should be connected at one end only.
- **Caution:** Some load cells connect the cable shield directly to the load cell (and therefore the scale base). Connection of the shield in this situation may be site specific.
- The instrument complies with relevant EMC standards provided case ground connection is correctly made. Resistance measured between **5000** case and nearest earth point should be less than 2 ohms.

4.2. Unused Pins

It is important to note that unused pins are not to be connected. The reason being that the functions of the pins may not be compatible with equipment at the other end (eg. connecting output pins to a PC communications port may affect the operation of the PC). Consequently many commercial communications cables are not suitable for use.

4.3. 5000 Rear Plate Connections

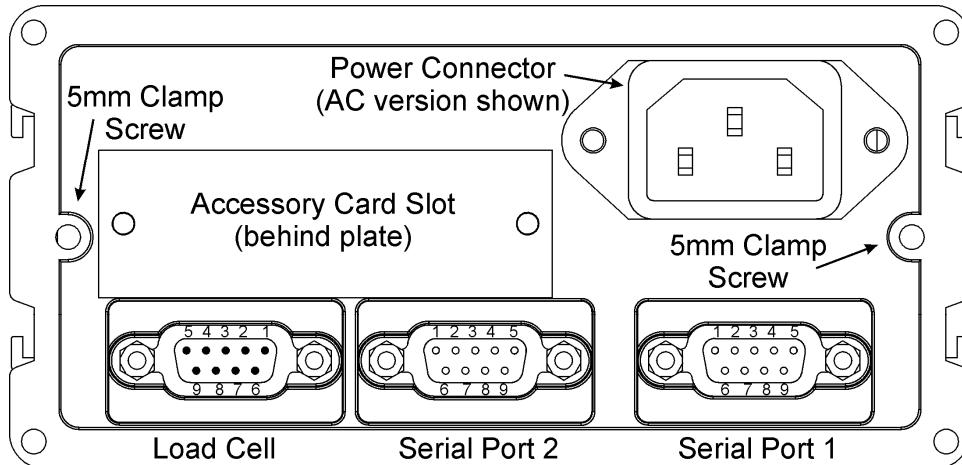

4.4. DC Power Supply

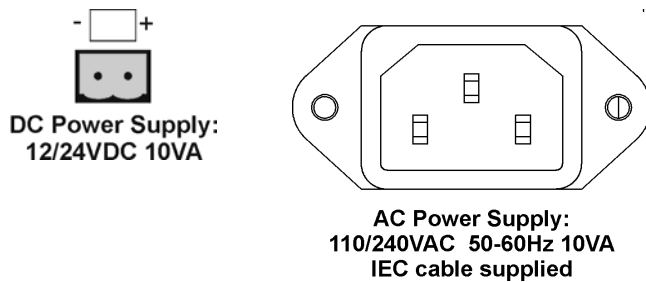

4.5. 6-Wire Load Cell Connection

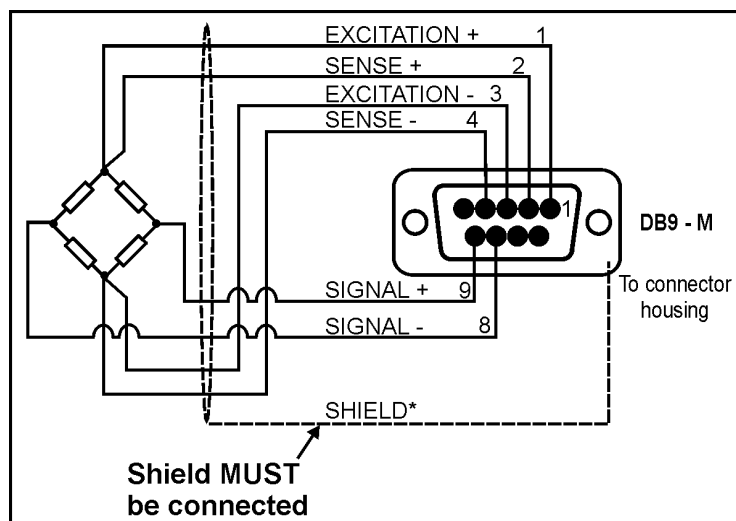

Note: Sense lines MUST be connected.

4.6. 4-Wire Load Cell Connection

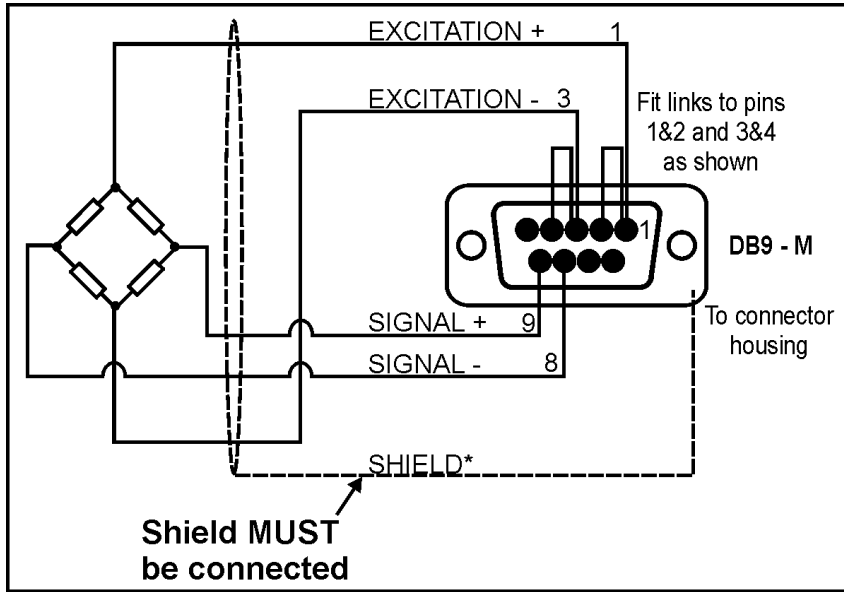

4.7. Serial Connection

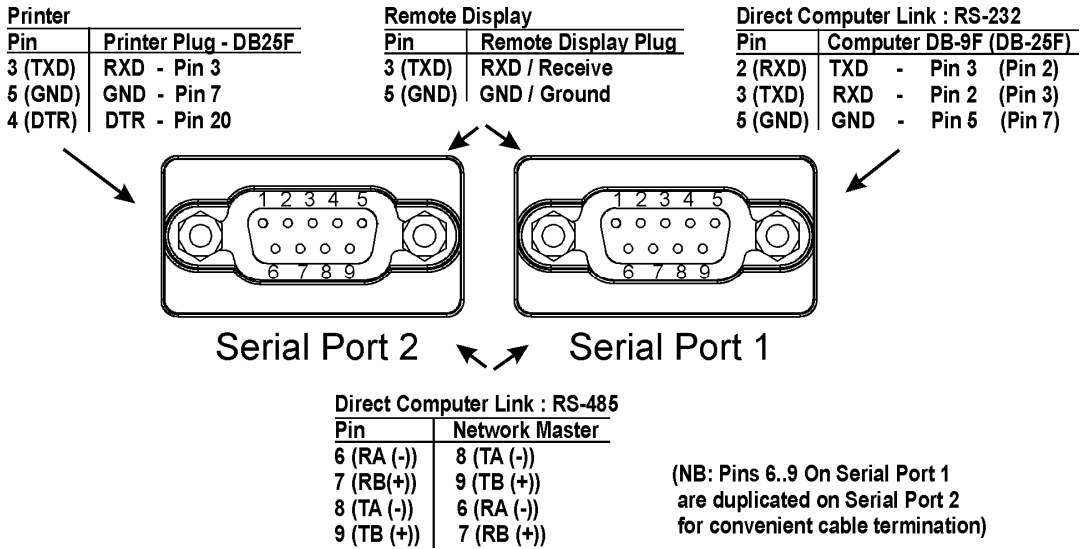

4.8. Accessory Card Installation

- Isolate the **5000** from the power before attempting to install an accessory card. Avoid excess handling of the accessory card as each card contains static sensitive devices. Hold the card by the edges or mounting plate as much as possible.
- Each option card is installed into a slot in the back panel of the **5000**. The slot is accessed by removing the cover plate at the top left. The connector lead is attached to the inside of this plate. Separate the lead from the plate taking care not to lose the lead inside the **5000**. Discard the plate, but retain the two mounting screws. Clean any remnants of tape from the lead connector.
- Plug the lead connector onto the four-pin socket on the accessory card. The connector only fits one way round.
- Slide the card into the slot in the back of the **5000**, cable end first, until the mounting plate is fitted against the back plate. Re-install the two retaining screws.

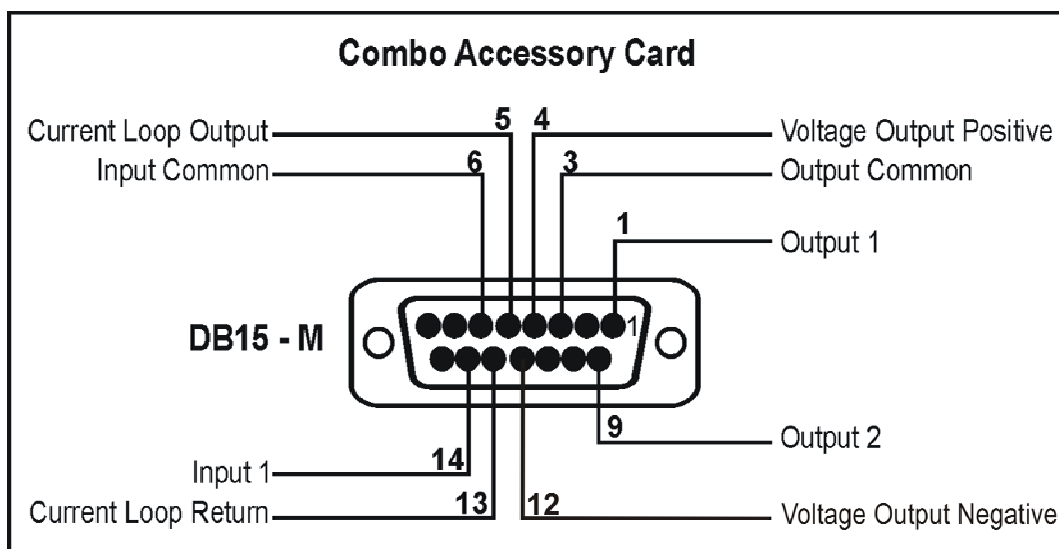
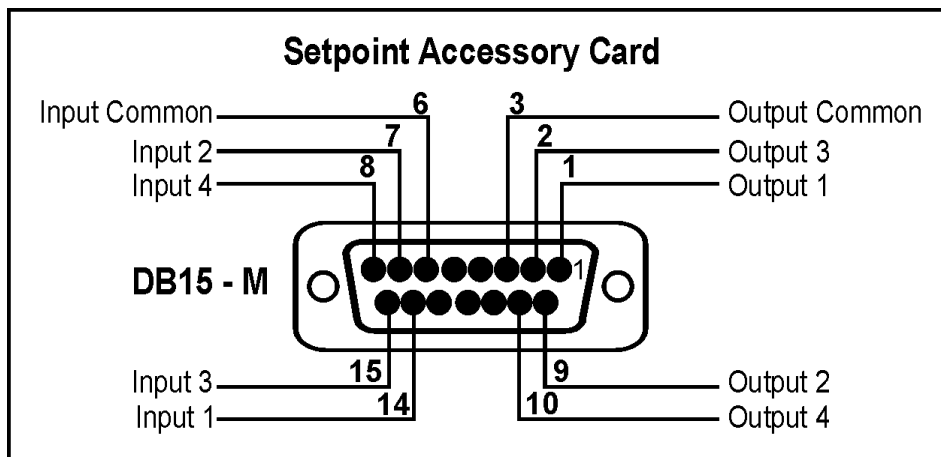

4.9. Accessory Card Connection



5. Setup

5.1. Accessing Full or Safe Setup

There are two methods of entering setup mode. One accesses the complete Full Setup. The other only allows access to the more restricted Safe Setup.

Full Setup	Safe Setup
 <p>(behind screw)</p>	
<p>To enter and exit Full Setup mode press the setup button (behind the setup screw).</p>	<p>To access Safe Setup press and hold the <GROSS/NET> key for two seconds</p>

If a Passcode has been set it is necessary to enter the appropriate passcode to gain access to the Setup.

Once access to the Setup has been achieved the display will show (SEtUP) for two seconds before displaying the first group title.

⊗	Items marked with ⊗ indicate that the setting is available only in Full Setup and is trade critical. When trade critical settings are changed the calibration counter will be incremented.
---	--

5.2. Exiting Full or Safe Setup

The following identifies the methods used to save settings, exit setup and return to the normal weighing mode.





5.2.1. Exiting Safe Setup





- Press the **[GROUP]** key until the **-END-** group appears in the display.
- Press the **[ITEM]** key to exit the setup.





5.2.2. Exiting Full Setup





This method may be used where the **<SETUP>** key is not sealed and can be freely accessed.

- Press the **<SETUP>** key once.
- Reseal the key with the seal screw. In trade applications, the screw head can be sealed with a destructible verification sticker.

 ZERO GROUP	 TARE ITEM	 GROSS/NET SELECT	 PRINT CHANGE
GROUP	ITEM	SELECT	CHANGE
BUILD	TYPE⊗	Scale ranging selection	SINGLE (single range) DUAL r (dual range) DUAL I (dual interval) DirEct (direct mV/V)
	DP⊗	Decimal point position	000000, 00000.0, 0000.00, 000.000, 00.0000, 0.00000
	CAP1⊗	Capacity of first range	Press <PRINT> key to increment the digit and <GROSS/NET> key to change to the next digit
	E1⊗	Resolution of first range	1, 2, 5, 10, 20, 50, 100
	CAP2⊗	Capacity of second range	Press <PRINT> key to increment the digit and gross/net key to change to the next digit
	E2⊗	Resolution of second range	1, 2, 5, 10, 20, 50, 100
	AD.TARE⊗	Additive Tare Limit	Press <PRINT> key to increment the digit and <GROSS/NET> key to change to the next digit
OPTION	USE⊗	Industrial or trade use	IndUST (+ and - weighing) or TRAdE (trade)
	FILTER	Digital Filtering/Averaging	1 (number of A/D readings to be averaged) or 2, 3, 4, 5, 6, 7, 8, 9, 10, 25, 50, 75, 100, 200
	JITTER	Display filter	OFF (stabilizes minor weight changes) FinE, COARSE
	MOTION⊗	Motion detection setting	NONE or 0.5 divs over 1.0 second in steps up to 5 divs per 0.2 second
	AUTO.Z	Auto zero on power up	OFF or ON
	Z.TRAC⊗	Zero tracking setting	NONE or 0.5 divs over 1.0 second in steps up to 5 divs per 0.2 second (affected by zero band)
	Z.RANGE⊗	Zero key range in percentages	02-02, 01-03, 20-20, 100.100
	Z.BAND⊗	Zero band width in divisions	(also limits zero tracking range)
	SENS.CH	Sense line check	OFF or ON
CAL	ZERO⊗	Current weight is displayed	Zero in progress [press <TARE> key to exit]
	SPAN⊗	Current weight is displayed	Enter in applied weight by a press of the <PRINT> key to increment the digit and <GROSS/NET> key to change to next digit [then press the <TARE> key] Span in progress [press <ZERO> key to exit]
	Ed.LIN⊗	Edit linearisation points	
	Clr.LIN⊗	Clear linearisation points	
	FAC.CAL⊗	Restore indicator to default factory configuration	Cont n (continue –No?) Cont Y (Yes) WARNING! All current setup will be lost – excluding zero and span

 GROUP	 ITEM	 SELECT	 CHANGE	
SERIAL	SER1	Function of serial port 1	NET (Rinstrum-Net used or Viewer software) OFF Auto.Lo (automatic output 10 updates/second) Auto.Hi (automatic output @ A/D frequency) Single (single weight output from Serial Port 1)	
	SER2	Function of serial port 2	OFF, Auto.Lo, Print, Single	
	ADDRES	Network address	00 to 31	
	AUT.OPT	TYPE Automatic output format		Auto.A (Rinstrum default string for all normal uses) Auto.B (see reference manual) Auto.C (see reference manual) Auto.D (see reference manual) Auto.E (see reference manual) CuStom (see reference manual)
		Src Source for automatic output		DISP (displayed weight) GroSS (gross weight) NET (net weight) Total (total weight)
		Aut.Fmt Programmable format		01.000 (posn.char) (see reference manual)
		ST.Chr Start character		002 (see reference manual)
		END.CH1 End character (1)		003 (see reference manual)
		END.CH2 End character (2)		000 (see reference manual)
		Prn.OPT	Prnt.TP Type of print-out	
	HEADER Custom ticket header			1.01.000 (line.pasn.char) (see reference manual)
	Tic.Fmt Custom ticket format			1.01.000 (line.pasn.char) (see reference manual)
	SPACE Ticket margin spacing			00.00 (columns.rows) (see reference manual)
	BAUD	Baud rate for both ports		300, 600, 1200, 2400, 4800, 9600, 19200
	BITS	Serial data format n 8 1 - 2 - Defaults as above are for: No parity 8 data bits 1 stop bit - termination resistors disabled RS-232 - no printer handshaking		N (no parity) O (odd parity) E (even parity) 8 (8 data bits) 7 (7 data bits) 1 (one stop bits) 2 (two stop bits) - (termination resistors disabled) T (termination resistors enabled) 2 (RS-232) 4 (RS-485) - (no printer handshaking) D (DTR handshaking)

 ZERO GROUP	 TARE ITEM	 GROSS/NET SELECT	 PRINT CHANGE
GROUP	ITEM	SELECT	CHANGE
SPEC	SAFE.PC	Set safe access passcode	
	FULL.PC ⊗	Set full access passcode	
	BUTTON ⊗	Zero, Tare, Gross/Net and Print key operations (all individually set)	YYYY (yes, buttons are active, but subject to motion detection for trade use) NNNN (no, buttons are disabled) iiii (active and over-rides motion detection)
	InP.Fn	Input functionally	O – Zero , t – Tare , G – Gross , P – Print B – Blank , L – Lock , S – Show total , C – Clear total , u – Undo , - Disable, r – Start, A – Pause/Abort, I – Interlock, d – Dump Enable, 1 – Serial 1, 2 –Serial 2 , H – Manual Hold, E – Peak Hold
	SYNC ⊗	A/D frequency (used for anti-vibration filter)	15 to 60 Hz (changes affects zero and span calibration)
TEST	SCALE	Displays the L/C output in Mv/V	X.XXXX (only lasts for 5 seconds in trade mode)
	Hi.Res	Expand the display resolution by 10 times	Off (In trade mode – only lasts for 5 seconds) On (tool for corner tests using minimal weights)
	Frc.Out	Force the outputs on the setpoint and combo cards	OFF, On1, On2, On3, On4
	tSt.inP	Displays the current status of the remote inputs on the setpoint and combo cards	[- - - - -] [-] no input present [1 to 4] input is active
	O-LOAD	Displays the the number of times that the instrument has been overloaded to above 135% of absolute fullscale	
SET.PTS	ACTIVE	Enable setpoints	- Off, A – Active, 1 – Material 1, 2 – Material 2, d – Dump, F – Finish, m – Motion, O – Zero, P - Pause
	LOC	Setpoint lock out	- Unlocked, L - Locked
	SRC	Source of weight data for analog output	GroSS (gross weight reading) NET (net weight reading)
	DIR	Output switching direction	O (Over – weight increasing to target) U (Under – weight decreasing to target)
	LOGIC	Active relay logic	H – High, L - Low
	ALARM	Setpoint alarms	- Off, S – Single beep, d – Double beep, C - Continuous
	TARGET	Target settings	Press <PRINT> key to increment the digit and <GROSS/NET> key to change to the next digit
	HYS	Weight tolerance settings	Press <PRINT> key to increment the digit and <GROSS/NET> key to change to the next digit
FLT	Setpoint in-flight settings	Press <PRINT> key to increment the digit and <GROSS/NET> key to change to the next digit	

 ZERO GROUP	 TARE ITEM	 GROSS/NET SELECT	 PRINT CHANGE
GROUP	ITEM	SELECT	CHANGE
AnAloG	SRC	Source of weight data for analog output	DISP (currently displayed weight, net or gross) GroSS (gross weight reading) NET (net weight reading)
	TYPE	Type of output	Volt (0-10 voltage output) Cur. (4-20mA current output) AbS.Cur (4-20mA absolute, + and - weighing)
	CAL.Lo	Zero calibration of analog outputs	UP (up fine adjustment) Dn (down fine adjustment)
	CAL.Hi	Span calibration of analog outputs	UP (up fine adjustment) Dn (down fine adjustment)
	Frc.AnL	Force analog readings for easy calibration of external devices	Lo (transmits 0V or 4mA, depending on TYPE) Hi (transmits either 10V or 20mA)
CLOC	TIME	Setting of current time	00HH.MM
	DATE	Setting of current date	00DD.MM
		Setting of current year	then 00.YYYY
	QA.OPT	Quality Assurance reminder	Off On (intermediately flashes QA Due on due date)
QA.dATE	Setting of QA date due Setting of QA year due	00DD.MM then 00.YYYY	
FACTRY	DEFLT⊗	Restore zero and span to factory default settings Warning: this sequence wipes all stored calibrations!	Cont n Cont Y (wipe all existing calibration data?)
	FAC.RST⊗	<Not Available> Factory access only	
	PRN.CFG⊗	Print out the entire settings of the 5000 on a connected printer on Serial 2	
-END-	SAVING	Exit, save changes and return to normal operation	

6. Error Messages

A number of error messages may be displayed to warn of operation outside of acceptable limits. These messages are given below. Short messages (xxxxx) will appear as a single message on the display. Longer messages (xxxxx)(yyyyy) will appear on the display in two parts, first the (xxxxx) part, then the (yyyyy) part.

6.1. Weighing Errors

These messages show status messages or errors that have occurred during the normal weighing operation.

Error	Description
(U - - - -)	The weight is below the minimum allowable weight reading.
(O - - - -)	The weight is above the maximum allowable weight reading. Warning - overloading may damage mechanical scale elements. (Check the condition of loadcell connections. Check for damaged load cell.)
(ZERO) (ERROR)	The weight reading is beyond the limit set for Zero operation. The operation of the <ZERO> key is limited in the setup during installation. Zero cannot be done at this weight. (Use TARE instead.)
(STABLE) (ERROR)	Scale motion has prevented a Zero, Tare or Print operation from occurring on command. (Try the operation again once the scale is stable.)
(PRINT) (ERROR)	A printer problem has prevented the printout from being completed. (Look for loss of printer power, no paper or cable fault.)
(CAL) (DUE)	The "calibration due" date has been set and the current date exceeds this limit. Press any key to clear the warning for 1 hour. To clear the warning permanently, recalibrate the instrument and set a new 'calibration due' date.

6.2. Setup Errors

These messages warn of setup entries that are not acceptable to the 5000 programme.

Error	Description
(RES) (LO)	The scale build is configured for less than 100 graduations. (Check the resolution (count-by) and Capacity settings)
(RES) (HIGH)	The scale build is configured for more than 100,000 graduations. (Check the resolution (count-by) and Capacity settings)

6.3. Calibration Errors

These messages warn of incorrect calibration technique, or of attempts to calibrate the 5000 beyond it's specification.

Error	Description
(ZERO) (HI)	The load cell output is beyond allowable zero calibration range. (Check for incorrect scale connection. Reduce the dead load, or shunt the load cells.)
(ZERO) (LO)	The load cell output is below allowable zero calibration range. (Check for incorrect scale connection. Increase the dead load, or shunt the load cells.)
(SPAN) (LO)	The load cell signal range (span) is too small for these settings. (Incorrect span weight entered. Scale wiring incorrect. Wrong load cell capacity [too large]. Wrong or no calibration weight added to scale.)
(SPAN) (HI)	The load cell signal range (span) is too large for these settings. (Incorrect span weight entered. Scale wiring incorrect. Load cell capacity too small for application.)
(NO) (ZERO)	There is no valid zero calibration so the span calibration cannot proceed.

6.4. Diagnostic Errors

The **5000** continually monitors the condition of the internal circuits. Any faults or out-of-tolerance conditions are shown on the display as an E type error message. In the table below the following terms are used:

- Check = this item can be checked on site by service personnel.
- Service = the **5000** must be returned for factory service.

Error	Description	Resolution
E0001	The power supply voltage is too low.	Check supply
E0002	The power supply voltage is too high.	Check scale / cables
E0004	The load cell excitation voltage is too low.	Check scale/supply
E0008	The load cell excitation voltage is too high.	Check scale/supply
E0010	The temperature is outside of allowable limits.	Check location
E0020	Scale build is incorrect. The number of graduations has been set < 100 or greater than 100000.	Fix up scale build
E0040	The positive sense line is not connected.	Check connection
E0080	The negative sense line is not connected.	Check connection
E00C0	Neither sense line is connected	Check connection
E0100	The digital setup information has been lost.	Re-enter setup
E0200	The calibration information has been lost.	Re-calibrate
E0300	All setup information has been lost	Enter setup and calibrate
E0400	The factory information has been lost.	Service
E0800	The EEPROM memory storage chip has failed	Service
E2000	The Clock Calendar chip has failed	Service
E8000	The EPROM memory storage chip has failed	Service

The **E** type error messages are additive. For example if a condition is detected where the power supply voltage is low, resulting in a reduction of excitation voltage, the resulting Error messages will be **E0005** (0001 + 0004). The numbers add in hexadecimal as follows:

1 - 2 - 3 - 4 - 5 - 6 - 7 - 8 - 9 - A - B - C - D - E - F

(For example, 2 + 4 = 6, or 4 + 8 = C

Notes:

Notes:

SMART WEIGHING SOLUTIONS

